

Contender™ CPS Factory Sealed 20 Amp Pin and Sleeve Receptacles

Explosionproof, Delayed Action

NEC/CEC:
Class I, Division 1 and 2, Groups C, D

Does not intermate with
CPS 20 Amp Factory Sealed Pin
and Sleeve Receptacles

Applications

- Locations where receptacles are used with stationary or portable electrically operated devices such as:
 - Lighting systems
 - Conveyors
 - Heaters
 - Motor-generator sets
 - Air conditioners
 - Compressors
 - Pumps
- Locations where damp or corrosive conditions exist.
- Meets all UL requirements for ground fault protection in hazardous locations when GFCI cover is used.

Features

- Covers are UL Listed when used with Contender™ Series mounting bodies.
- Plug mechanical cable clamps prevent strain on cables – they meet or exceed UL strain relief pull-out requirements.
- Insulators provide superior dielectric and mechanical strength and lowest arc tracking.
- Delayed action construction: insert plug partially rotate slide on front of receptacle and insert plug fully.
- Factory sealed: external seals not required.
- Plug and receptacles are supplied with pressure terminal connectors.

Standard Materials

- Cover: copperfree (4/10 of 1% max.) aluminum
- Mounting bodies: malleable iron
- Screws: captive hex head slotted, stainless steel
- Insulating blocks: fiberglass reinforced thermoset polyester
- Plug grommet: neoprene

Standard Finishes

- Malleable iron mounting bodies: triple-coat– (1) zinc electroplate, (2) chromate and (3) epoxy powder coat
- Covers and aluminum mounting bodies: epoxy powder coat

Options

- Copperfree (4/10 of 1% max.) aluminum receptacle cover and box. Add suffix **-SA**.
- U-Line™ Corrosion Resistance kit. Order **ULINEREC4XKIT**.

NEC/CEC Certifications and Compliances

- UL Standard: UL 1010 (UL 1203), UL 894
- cULus Listed: E10784



APPLETON™

PLUGS AND RECEPTACLES: NEC/CEC HAZARDOUS LOCATION



Note: Appleton Contender CPS Receptacles are UL Classified for use with Crouse-Hinds CPP516 plug.

Contender™ CPS Factory Sealed 20 Amp Pin and Sleeve Receptacles

Explosionproof, Delayed Action

NEC/CEC:
Class I, Division 1 and 2, Groups C, D

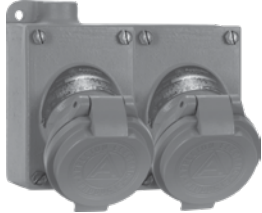
**Does not intermate with
CPS 20 Amp Factory Sealed Pin
and Sleeve Receptacles**

		Type	Wire/Pole	Hub Size (Inches)	Catalog Numbers ① 20 Amp 125–250 Vac 1HP, 20 Amp @ 18 Vdc
Single Gang					
 <p>Dead-End Feed-Thru</p>	Dead-End	2W, 3P	1/2	CPS152-101	
			3/4	CPS152-201	
			1	CPS152-301	
	Feed-Thru	2W, 3P	1/2	CPS152-111	
			3/4	CPS152-211	
			1	CPS152-311	
Two Gang					
	Dead-End	2W, 3P	1/2	CPS152-102	
			3/4	CPS152-202	
			1	CPS152-302	
	Feed-Thru	2W, 3P	1/2	CPS152-112	
			3/4	CPS152-212	
			1	CPS152-312	
Receptacle with GFI ②					
	Dead-End	2W, 3P	1/2	CPS152-102GFI	
			3/4	CPS152-202GFI	
			1	CPS152-302GFI	
	Feed-Thru	2W, 3P	1/2	CPS152-112GFI	
			3/4	CPS152-212GFI	
			1	CPS152-312GFI	

APPLETON™

PLUGS AND RECEPTACLES: NEC/CEC HAZARDOUS LOCATION

① Aluminum receptacle cover and malleable iron EDS box. For aluminum box and receptacle cover, add suffix **-SA**.

② GFI units rated 20 Amp, 125 Vac.





Note: Appleton Contender CPS Receptacles are UL Classified for use with Crouse-Hinds CPP516 plug.

Contender™ CPS Factory Sealed 20 Amp Pin and Sleeve Receptacles

Explosionproof, Delayed Action

NEC/CEC:
Class I, Division 1 and 2, Groups C, D

Does not intermate with
CPS 20 Amp Factory Sealed Pin
and Sleeve Receptacles

		Type	Wire/Pole	Plug Cable Diameter (Inches)	Catalog Numbers ① 20 Amp 125–250 Vac 1HP, 20 Amp @ 18 Vdc
Cover Assemblies					
		Receptacle with Spring Cover Only			CPS152R
		GFCI Cover, 5 mA Trip Setting ②			GFS1
CPS152R	GFS1				
<hr/>					
		Spring Cover Replacement Kit (Aluminum)			CPSCA
CPSCA					
<hr/>					
Plug		Pressure Terminals	2W, 3P	0.538 to 0.639	CPP516
		Plug amperes match receptacle ratings			

APPLETON™

PLUGS AND RECEPTACLES: NEC/CEC HAZARDOUS LOCATION



① Aluminum receptacle cover and malleable iron EDS box. For aluminum box and receptacle cover, add suffix **-SA**.
 ② GFI units rated 20 Amp, 125 Vac.
 Note: Appleton Contender CPS Receptacles are UL Classified for use with Crouse-Hinds CPP516 plug.

Contender™ CPS Factory Sealed 20 Amp Pin and Sleeve Receptacles

For Contender™ CPS 20 Amp Factory Sealed Receptacles and CPP Plugs. Mounting Boxes

NEC/CEC:
 Class I, Division 1 and 2, Groups C, D
 Class II, Division 1 and 2, Groups E, F, G
 Class III
 NEMA 3, 7CD, 9EFG

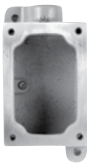
EDS Cast Device Mounting Boxes

Type	Hub Size (Inches)	Dimensions in Millimeters (Inches)			Catalog Number		
		A	B	C	Malleable Iron	Aluminum	
Single Gang							
	Dead-End	1/2	153.9 (6.06)	172.9 (6.81)	19.0 (0.75)	EDS171	EDS171-SA
		3/4	153.9 (6.06)	172.9 (6.81)	22.3 (0.88)	EDS271	EDS271-SA
		1	156.7 (6.17)	178.5 (7.03)	25.4 (1.00)	EDS371	EDS371-SA
	Feed-Thru	1/2	153.9 (6.06)	172.9 (6.81)	19.0 (0.75)	EDSC171	EDSC171-SA
		3/4	153.9 (6.06)	172.9 (6.81)	22.3 (0.88)	EDSC271	EDSC271-SA
		1	156.7 (6.17)	178.5 (7.03)	25.4 (1.00)	EDSC371	EDSC371-SA
Two Gang							
	Dead-End	1/2	153.9 (6.06)	172.9 (6.81)	22.3 (0.88)	EDS172	EDS172-SA
		3/4	153.9 (6.06)	172.9 (6.81)	22.3 (0.88)	EDS272	EDS272-SA
		1	156.7 (6.17)	178.5 (7.03)	25.4 (1.00)	EDS372	EDS372-SA
	Feed-Thru	1/2	153.9 (6.06)	172.9 (6.81)	22.3 (0.88)	EDSC172	EDSC172-SA
		3/4	153.9 (6.06)	172.9 (6.81)	22.3 (0.88)	EDSC272	EDSC272-SA
		1	156.7 (6.17)	178.5 (7.03)	25.4 (1.00)	EDSC372	EDSC372-SA
Tandem ①							
	Dead-End	1/2	287.2 (11.31)	307.0 (12.09)	22.3 (0.88)	EDS147	EDS147-SA
		3/4	287.2 (11.31)	307.0 (12.09)	22.3 (0.88)	EDS247	EDS247-SA
		1	290.5 (11.44)	312.6 (12.31)	25.4 (1.00)	EDS347	EDS347-SA
	Feed-Thru	1/2	287.2 (11.31)	307.0 (12.09)	22.3 (0.88)	EDSC147	EDSC147-SA
		3/4	287.2 (11.31)	307.0 (12.09)	22.3 (0.88)	EDSC247	EDSC247-SA
		1	290.5 (11.44)	312.6 (12.31)	25.4 (1.00)	EDSC347	EDSC347-SA

Dimensions in Millimeters (Inches)

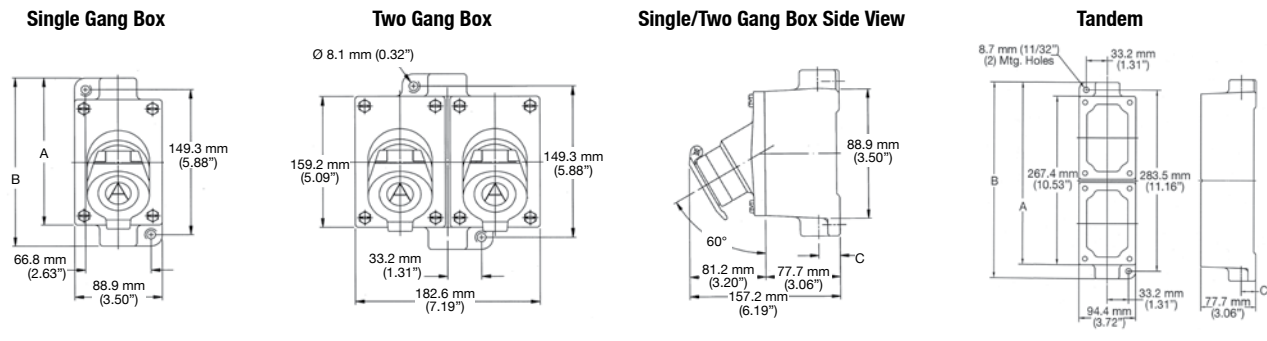

① For tandem bodies, external seals must be installed within 1.52 meters (5 feet) of each conduit entrance for Class I, Groups C and D.

Contender™ CPS Factory Sealed 20 Amp Pin and Sleeve Receptacles

Explosionproof, Delayed Action

NEC/CEC:
 Class I, Division 1 and 2, Groups C, D
 Class II, Division 1 and 2, Groups E, F, G
 Class III
 NEMA 3, 7CD, 9EFG

Dimensions in Millimeters (Inches)

GFS-1

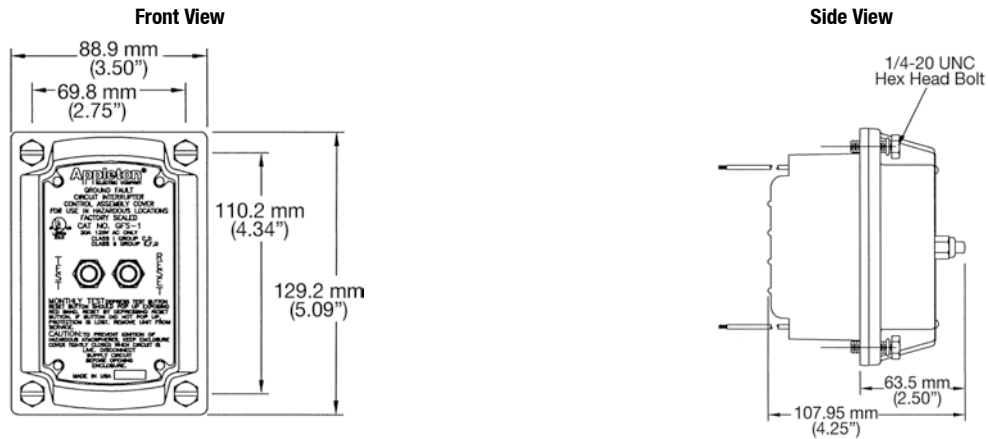

CPP Plug

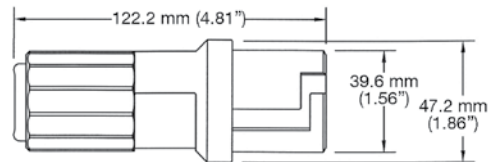

APPLETON™

PLUGS AND RECEPTACLES: NEC/CEC HAZARDOUS LOCATION